

SPECIFICATION SHEET

TYPE: The Crane shall be a fold a way bumper mounted type, for mounting to vehicles 78" to 102" in width. (3) (shall be custom built to the vehicles width)

CAPACITY: The Crane shall have a designated lifting capacity of 1350 lbs.

BOOM HEIGHT: (1) The Boom shall be a fixed position boom with an overall height of 77" & 85" from top of bumper.

BOOM LENGTH: (2) The Boom shall have a fixed length of 45".

ROTATION: The Crane shall have a 360-degree continuous manual rotation on machined surfaces, with two needle bearings and one thrust bearing that are environmentally sealed.

HOIST: The Hoist Motor shall be 12 volt D.C. powered, with a dual internal breaking system. Hoist shall have power up and power down.

CABLE: (6) The Cable shall be 25' x 3/16 in diameter galvanized aircraft quality cable, with a single line breaking strength of 4200 lbs., and a safety hook.

CONTROL: A Hand Held Pendant Control, 10 feet in length, shall be furnished for controlling the hoisting function and shall be 12 volt D.C. powered. Pendant Control shall be weather resistant, with a solid rubber grip.

POWER SOURCE: The Power Source shall be the vehicles own 12-volt D.C. battery.

OUTRIGGER: The Crane shall have a permanently attached swing down adjustable outrigger, to increase stability and reduce the loading to the vehicle's suspension.

HITCH: The Bumper shall have a factory installed Class 4 Receiver type hitch. This Hitch is rated at 10,000 lbs. of drawbar pull and 1,200 lbs. vertical Hitch load. *(Vehicle's rated towing capacity may be less)*

MOUNTING: The Crane shall be provided with all necessary wiring, brackets, fasteners, and hardware, for bolt on mounting to the vehicle's frame. Note: Mounting to custom bodies or modified frames may require adaptation of supplied mounting brackets.

WIRING: The Crane shall be pre-wired from the factory and tested. The Cranes entire electrical system shall be circuit breaker protected.

SAFETY: The Crane shall be designed and manufactured according to the applicable ANSI standards for mobile cranes. The Crane shall be clearly marked with Maximum Load & Warning Decals.

MAN-LIFT: The Crane shall be OSHA & ANSI compliant as a Man-Lift for Confined Space Activities when equipped with the optional WO-CSR Confined Space Rescue & Recovery System.

CONSTRUCTION: The Bumper shall be of 2" X 5" tubular steel construction. The Mast shall be seamless DOM tubing with strong back. The Boom shall be formed from 1 piece of 3/16" ASTM A572 Grade 50 High Tensile Steel. All Sheaves shall be steel with replaceable oil-impregnated bushings. All Sheave Pins shall be made from plated stress proof steel.

DOCUMENTATION: The Crane shall be furnished with detailed Installation Instructions, Operation and Safety Instructions, Parts List, and Maintenance Instructions.

FINISH COATING: The Crane shall be finished with a durable Powder Coating, semi-gloss black.

WARRANTY: Manufacturer shall warrant the materials and workmanship for a period of one year from the date of delivery (excluding cable).

- | | |
|------------------|-----------|
| 1: Boom Height | 77" & 85" |
| 2: Boom Length | 45" |
| 3: Bumper Width | 78"-102" |
| 4: Bumper Height | 11" |
| 5: Bumper Depth | 9" |
| 6: Cable Length | 25' |

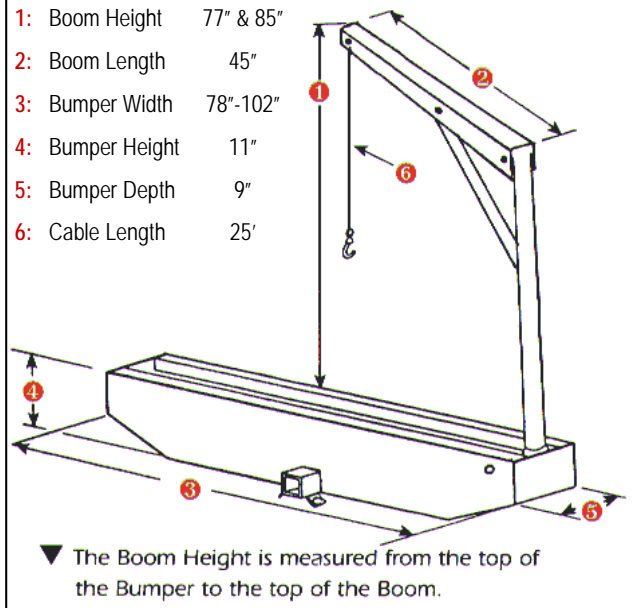

NOTE: OPTIONS AND ACCESSORIES ARE AVAILABLE FOR THIS MODEL
See "Options & Accessories Specifications" for details.

